



IsoFlex Technologies Pty Ltd.

Unit 5, 7 Waterway Drive, Gold Coast Marine Precinct, Coomera, Queensland, Australia. 4209
 Ph: 1300 366 393 Ph: 07 555 60 924 F: 07 555 60 984 Int prefix: 617
 Email: info@isoflex.com.au
 Home Page: www.isoflex.com.au

IsoFlex Mount Data Sheet

Loading:

1. Axial - Vertical Down (A-direction)

Mount Model: M30HD-12B

'M30HD' = model number
 '12' = thread size
 'B' = bolt type

Resilient Element Colour	Shore Durometer Hardness A-scale SDH-A
Yellow	50
Red	60
Black	70
Royal Blue	75
Green	80

Base: Black - 75 SDH-D

All metal components silver zinc plated

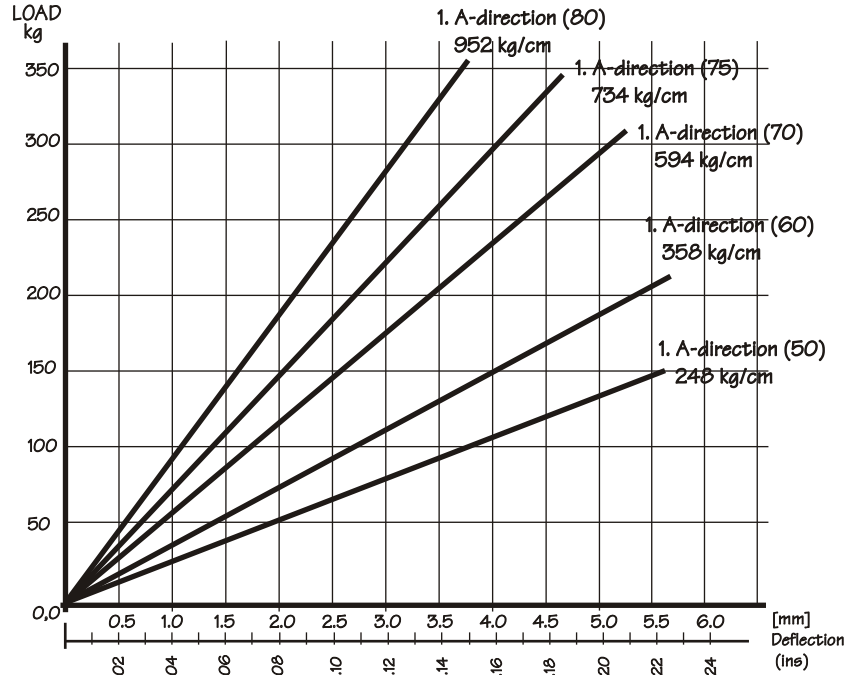

Graph:

1. Static Axial Vertical Load[kg] (A-direction) versus Deflection[mm] (in)

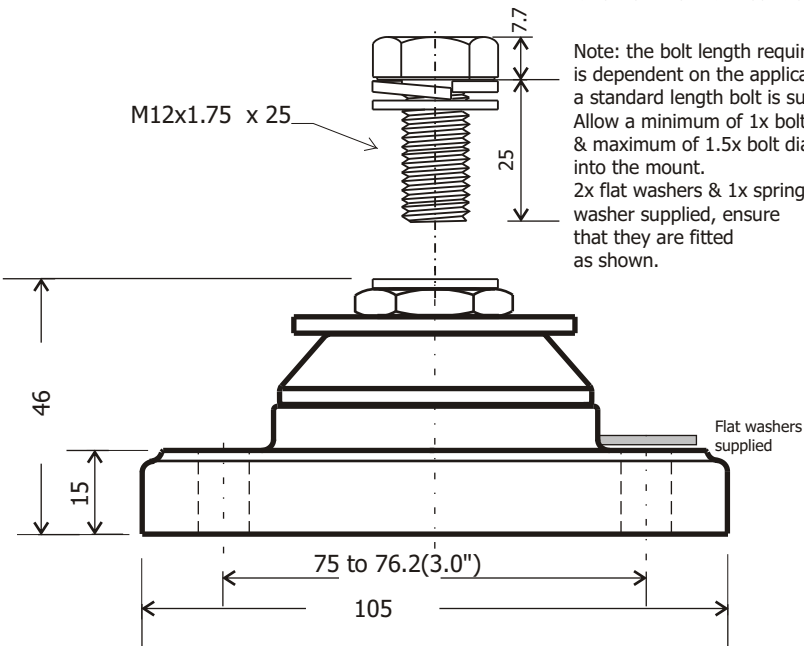

Model Number: M30-12B(50) illustrated

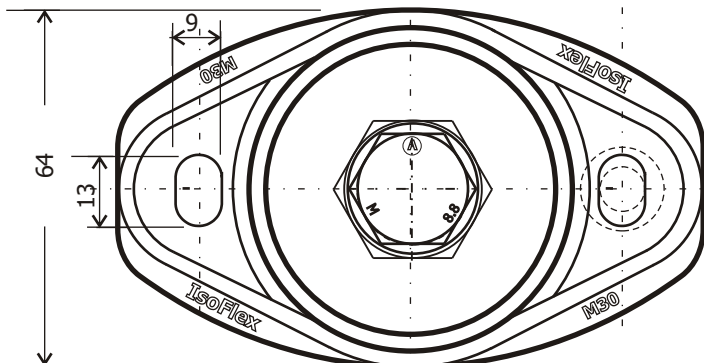

IsoFlex Mount Model Number: **M30HD-12B**

Dimensions in millimetres (mm.) - unless stated otherwise

Drawing number: DSA-M30HD-12B
 Drawn: PB Date: 13-6-07

Copyright © 2007 **IsoFlex Technologies Pty Ltd.**

Specifications are subject to change without notice.