



IsoFlex Technologies Pty Ltd.

Unit 5, 7 Waterway Drive, Gold Coast Marine Precinct, Coomera, Queensland, Australia. 4209
 Ph: 1300 366 393 Ph: 07 555 60 924 F: 07 555 60 984 Int prefix: 617
 Email: info@isoflex.com.au
 Home Page: www.isoflex.com.au

IsoFlex Mount Data Sheet

Loading Type:

Axial - Vertical Down (A-direction)

Mount Model: M110-24S

'M110' = model number
 '24' = thread size
 'S' = adjusting stud type

Resilient Element Colour	Shore Durometer Hardness A-scale SDH-A
Yellow	50
Red	60
Black	70
Royal Blue	75
Green	80
Grey	90

Base: Black - 75 SDH-D

All metal components silver zinc plated

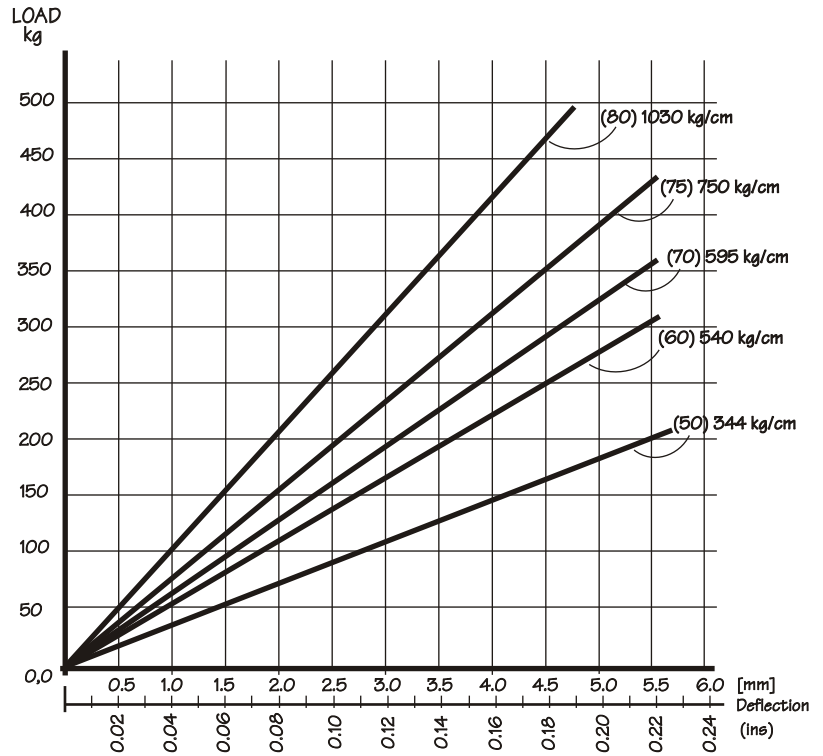

Graph 1: Static Axial Vertical Load [kg] (A-direction) versus Deflection [mm] (ins)
 Data shown: (x) = SDH-A Hardness
 kg/cm = Spring Rate

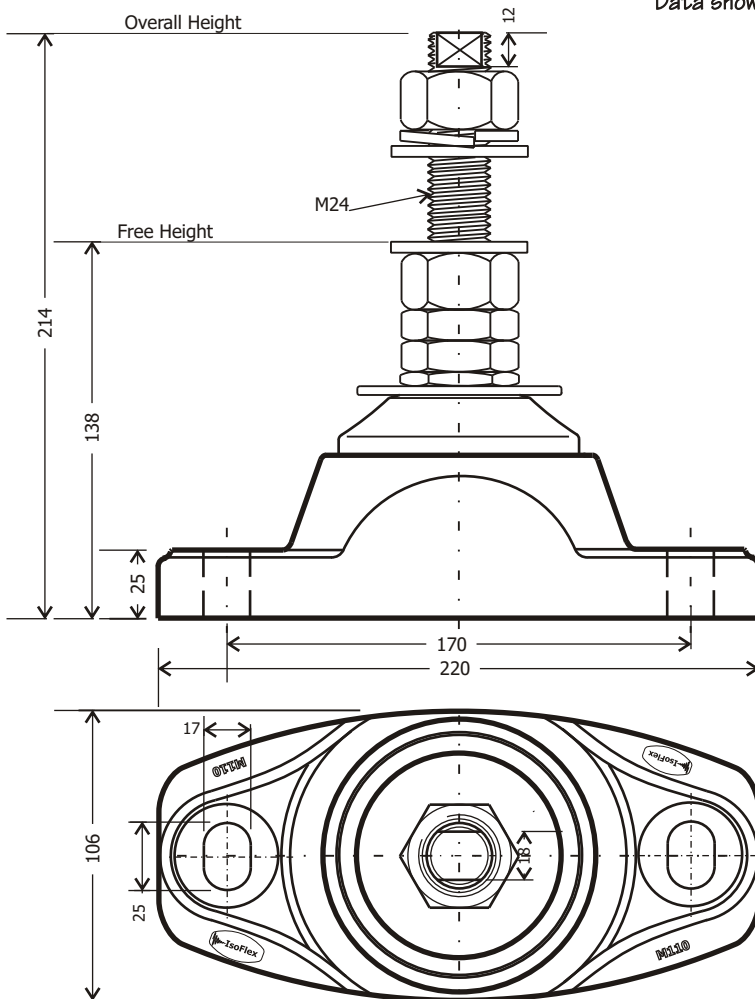

M110-24S General Arrangement

Dimensions in millimetres (mm.) - unless stated otherwise



Model Number: M110-24S(60) illustrated

Drawing number: DSA-M110-24S
 Drawn: PB Date: 25-9-06

Copyright © 2006 **IsoFlex Technologies Pty Ltd.**

Specifications are subject to change without notice.